

MONITORE A COMANDI ELETTRICI – Mod. FI-EMP6 ELECTRIC REMOTE CONTROLLED MONITOR – Mod. FI-EMP6

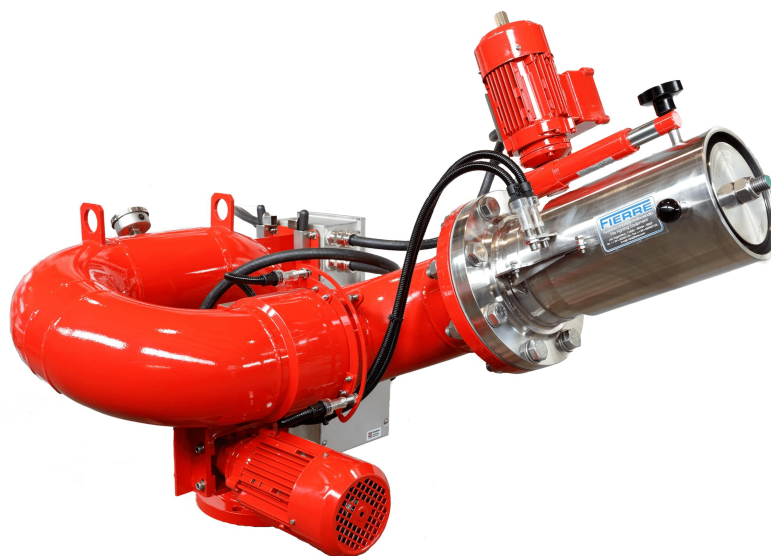

CARATTERISTICHE TECNICHE:

- = Corpo in acciaio inox
- = Flange in inox
- = Rotazione su Giunti A Doppia Corona e Anelli di Tenuta In Nbr
- = Comandi D'emergenza Manuall A Volantino
- = Rotazione +175° -175° / Alzo +70° -70°
- = Alimentazione Elettrica 380V - 3 Fasi -50Hz
- = Monitori Elettrici Esecuzione IP 66 O Eexd
- = Interruttori Fine Corsa Disponibili N°1 Alzo, N°1 Rotazione

A RICHIESTA:

- = Alimentazione: 440V-60Hz-3FASI
24V D.C.
230V-50Hz-1FASI
- = Accessori: Encoder, Absolute Positioning Sensors

TECHNICAL CHARACTERISTICS:

- = Body made of stainless steel
- = Flange made of stainless steel
- = Rotating Join With Two Ring Sphere And Nbr Tightness
- = Manual Emergency Operation With Handweels
- = Rotation +175° -175° / Elevation +70° -70°
- = Feeding Voltage 380V – 3 Phases – 50Hz
- = Elettric Motor IP 66 Execution Or Eexd
- = Limit Switch Suitable

ON REQUEST:

- = Feeding Voltage: 440V-60Hz-3PHASES
24V D.C.
230V-50Hz-1PH
- = Accessories: Encoder, Absolute Positioning Sensors

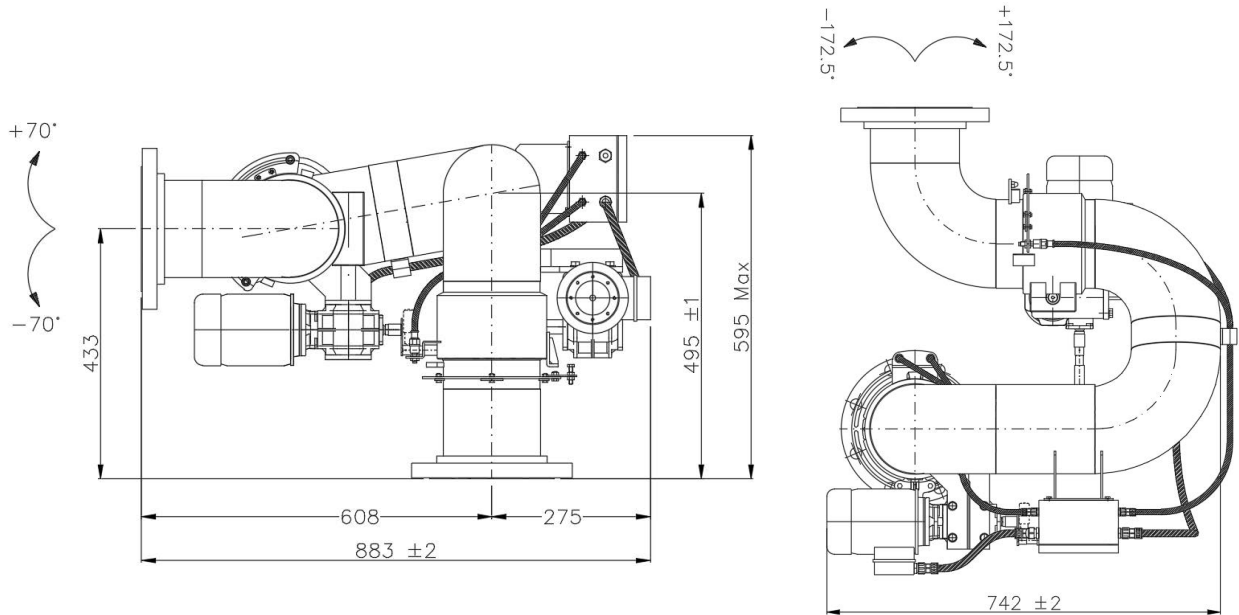

MODELLO	Diametro flange ingresso	Corpo	Portata massima	Materiale Corpo	Peso
MODEL	Inlet connections size	Body	Max. Capacity Lt/1'	Body Material	Weight
FI- EMP6	6" / 8" UNI / ANSI	6"	10.000	Acc. Inox 304/316 Stainless stell	IP 65 71 Kg ATEX 78 Kg

